

S-3FPARTS INNOVATIONS LLP

Company No: ACI-7026

GST NO: 24AFJFS3134B1ZE

Email: 3fparts@gmail.com

Phone: 7435071980

Our Address: No-19(A) Shrine Estate, Kewal Kanta
Road, Opp. Nanavati Estates, Rakhial Ahmedabad,
Gujarat 380023 India

Technical Data Sheet

M1.6 x 6mm CSK Phillips Countersunk Machine Screws (DIN 965) - Stainless Steel 304 (A2-70)

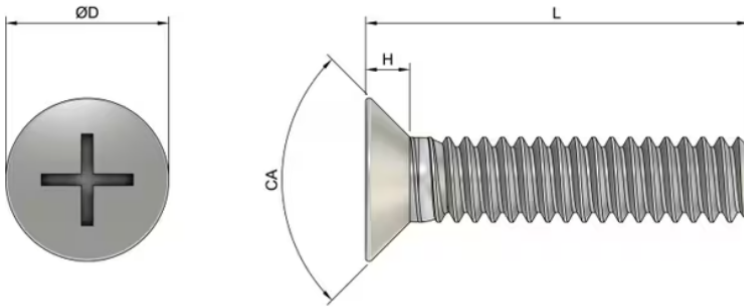

3FParts Product Code (3PC)	3F-00125-406-1697
Countersunk Angle (CA)	90 Degrees, Tolerance: +2/-0 Degrees
Countersunk Length (H)	0.96mm
Head Diameter (Max) (D)	3mm
Drive Size	PH0
Manufacturing Standard	DIN 965
Material	Stainless Steel 304 (A2-70)
Thread Size (Dia.)	M1.6
Length (L)	6mm
Fully Threaded	Yes
Thread Pitch	0.35 mm